



TSL1000

Domestic Step Lift

TerryLifts
total lift solutions

The Specialist in Mobility Lifts
Trusted for over 50 years

Buy direct from the British manufacturer

www.terrylifts.co.uk/lifts

Call **01565 752800** for free and impartial advice



TSL1000 Domestic Steplift

Practical: As well as providing wheelchair access, the TSL1000 can also accommodate pedestrian access when supplied with bridging steps.

Easy to use: Convenient controls to the carriage, upper and lower levels (remote option also available). Shallow approach ramp for easy access onto the lift platform.

Easy installation: Self-contained unit is suitable for mounting on to a 100mm concrete base and can be easily installed in less than a day.

Cost effective: Often cheaper than a ramp and can be easily re-sited.

Reliable: Battery back-up provides normal operation in case of a power cut

Low maintenance: Annual servicing recommended. Service contract available

Safe: Built in the UK to BS 6440:2011 by a Company with over 50 years' experience in mobility and access Products.

Versatile: The TSL1000 will travel up to 1000mm with upper gate protection or 960mm with a triple bridge unit.

Unobtrusive: Blends into its surroundings.

Standard Specification

- Can be sited internally or externally for wheelchair use only.
- Maximum safe working load: 250Kg.
- Closed height: 75mm.
- Maximum height served: 1000mm.
- 800mm x 1450mm useable platform size.
- Power supply electrical requirements: 220 / 240V~50 / 60 Hz-13A single phase.
- Low voltage 24V DC control system.
- Operating temperature range: -10°C to +40°C.
- Automatic wheelchair arrestor mechanism.
- Full battery back-up.
- Constant pressure controls.
- Hydraulic drive system with scissor mechanism and underside bellows cover system.

Options Available

- Single, Double or Triple bridging step.
- Upper level gate with interlock -Powered or Manual.
- Gate interlock for customer supplied upper gate.
- Remote isolate or enable fob.
- Alternative colours to painted parts.
- Pit installation (internal applications only).
- 900mm wide platform
- Painted or stainless steel post for call station mounting.

Dimensions

All dimensions in mm

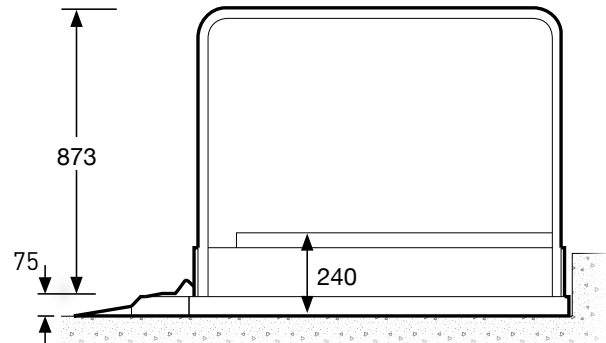
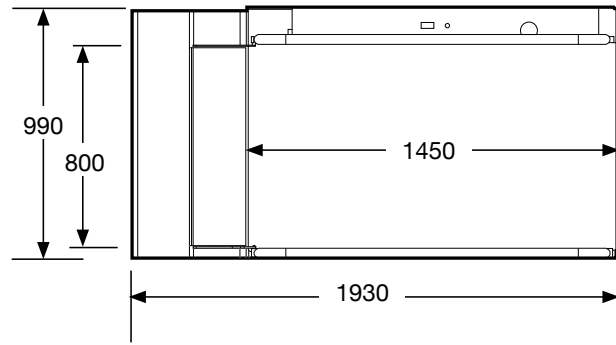

1000mm maximum rise



Terry Lifts
total lift solutions

Terry Group Ltd. Unit 1-3,
Longridge Trading Estate
Knutsford, Cheshire WA16 8PR

Tel: +44 (0)1565 752 800
www.terrylifts.co.uk
enquiries@terrylifts.co.uk



Issue date: 2/2022